

Installation and Care Instructions

Window Shades

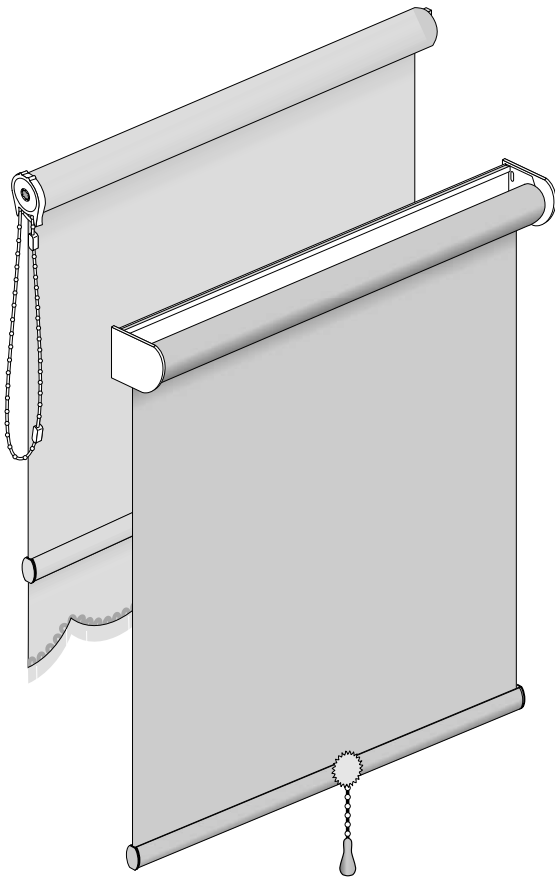

HunterDouglas
window fashions

REMEMBRANCE® WINDOW SHADE INSTALLATION AND CARE INSTRUCTIONS

THANK YOU for purchasing a Hunter Douglas Remembrance® window shade. Your new shade has been custom built for you from the highest quality materials. Once in your window, it will provide you with a lifetime of beauty and trouble-free use.

Getting Started

- Remove the shade from the package. Keep the packaging until the shade operates to your satisfaction. Do not remove the paper banding around the roller tube.
- Check the diagram to make sure you have the necessary parts.

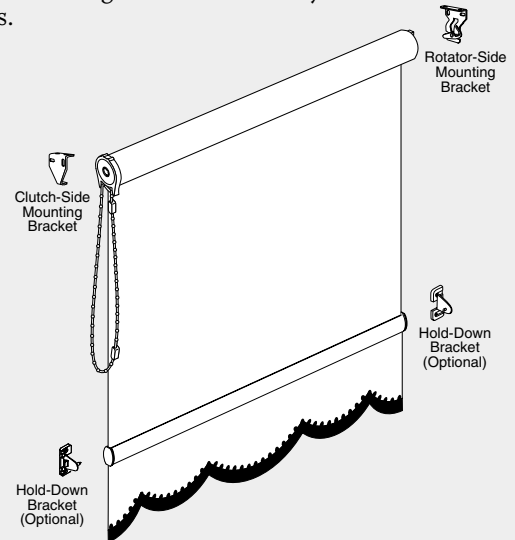

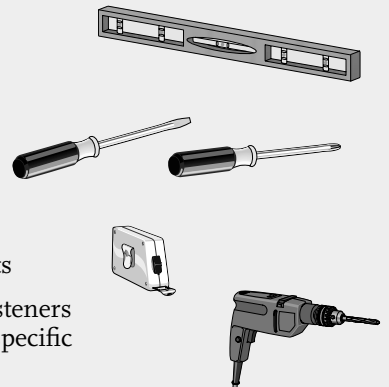

Tools needed for installing your shade:

- Carpenter's Level
- Flat Blade Screwdriver
- Phillips Screwdriver
- Measuring Tape
- Power Drill and Drill Bits



In addition, you will need fasteners designed to work with your specific mounting surfaces:

Mounting Surface	Fastener
Wood	No. 6 Hex Head Screws (Provided) 
Drywall, Plaster	Wall Anchors, Expansion Bolts (Not Provided) 
Metal	Sheet Metal Screws (Not Provided) 

Contents of your hardware package may vary depending upon how the shade was ordered and whether the shade will be mounted inside or outside the window opening.

For assistance, call the Hunter Douglas
Customer Information Center at
1-888-501-8364
7:00 AM to 4:30 PM MST, Mon.-Fri.
Visit our Web site at hunterdouglas.com

Clutch Operated Shade Installation

The installation brackets are supplied in pairs. One bracket is used with the control side of the shade (the side with the beaded cord) and the second bracket is used with the rotator side.

The roller shade can be mounted inside or outside the window casement, or mounted to the ceiling. The parts labeled “foot”, “T-hook”, and “center opening” hold the shade in place.

The installation brackets are always mounted so that the inner surfaces face each other, as shown. It is very important that the brackets are mounted so that the shade is level when installed.

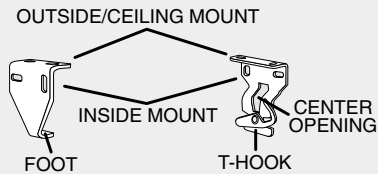

The brackets are attached to the inside of the window casement for an inside mount, or to a wall or window frame for an outside mount. The brackets are attached to the ceiling for a ceiling mount.

Control-Side Installation Brackets

Place the foot of the control-side bracket into the slotted center hole of the clutch. If the shade is inside or outside mounted, the bracket should be mounted so that the foot is pointing away from the window. If the shade is ceiling mounted, the bracket should be mounted so that the foot is pointing down to the floor.

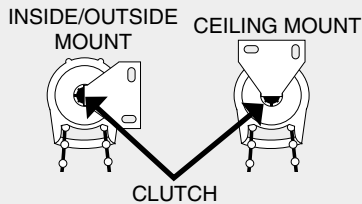

Hold the shade in the desired position at the window and mark the bracket location on the mounting surface. Remove the shade from the window and drill the bracket mounting holes. Use two screws (and anchors, if needed) to attach the mounting bracket to the mounting surface.

Rotator-Side Installation Bracket

Fit the pin on the rotation end of the shade into the rotator-side installation bracket. If the shade is inside or outside mounted, the pin fits into the T-shaped hook on top of the bracket. If the shade is ceiling mounted, the pin fits into the center opening of the bracket.

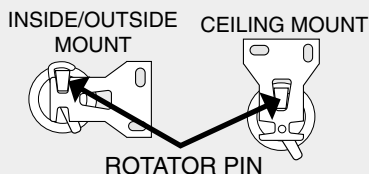

To position the rotator-side bracket, install the control side of the shade, supporting the rotator-side. Place the rotator-side bracket into the rotator pin, and position it against the mounting surface. Before marking the bracket location, use a carpenter’s level to make sure the shade is level.

(If mounting the brackets to the ceiling, you may need to shim one of them to level the shade.)

When the shade is level, mark the rotator-side bracket location on the mounting surface and drill the mounting holes. Use two screws (and anchors, if needed) to attach the bracket to the mounting surface.

Install the Shade Assembly

Hold the shade with the bottom of the clutch facing the floor, and the beaded cord hanging straight down.

First, install the clutch end of the shade; once installed properly, install the rotator side.

Important: After installing the shade assembly, remove the paper banding to prevent shade from unrolling prematurely.

Clutch Operated Shade Adjustment

Using the beaded cord, lower the window shade to the full drop. Raise the shade slowly and observe how the fabric winds on the roll. Level mounting is essential for proper operation. If the fabric winds unevenly and begins to telescope to one side, check to insure that the shade is level. If the shade is not level, remove it from the installation brackets and shim or re-install the brackets, as necessary.

Important: If the shade was unrolled before being installed, it may not raise and lower to the right points. To correct this:

- 1) remove the shade from the mounting brackets;
- 2) roll up the shade until the bottom rod is even with the bottom of the clutch;
- 3) re-install the shade.

Standard Shade Length Adjustment

If your shade is slightly long or short for your window opening, the “drop” can be adjusted in the following manner:

1. Raise the shade completely (until the connector touches the back of the clutch).
2. Pry the second connector open with a small thin screwdriver. Do not let the blade slip!
3. Move connector two to four beads up for a shorter drop or two to four beads down for a longer drop. (Maximum adjustment is 1³/₄” or four to five beads.)

Clutch Operated Shade Removal

Release the T-hook on the rotator bracket and slide the rotator side of the shade up. Gently pull the opposite end from the bracket.

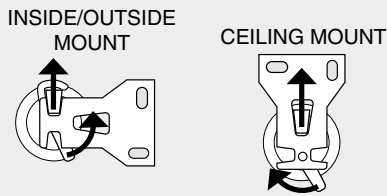

Child Safety Tensioner Installation for Clutch Operated Shades

Warning for Parents: Children could accidentally strangle in the window covering cords. Keep the beaded cord out of reach for children with the Hunter Douglas Tension device. The Tension Device reduces the hazards of strangulation and entanglement of young children by limiting access to the control cord. Anchor the Tension Device bead chain, to the window frame or wall preventing children from wrapping the cord around their necks.

1. Lower the shade.
2. Hold the Tension Device upright so the Warning Tag hangs straight down.
3. Position the Tension Device on the window frame or the wall so that the Tension Device and the bead chain do not interfere with raising or lowering the shade or blind.
 - a. The bead chain must be taut, but still operable; do not allow for any slack.
 - b. Do not twist or cross the bead chain.
4. Holding the Tension Device upright, taut, and in position, as shown, insert and secure the screw into the hole.

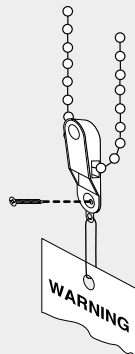

Note: The mounting screw must be secured on a solid surface.

Getting Started

- Remove the shade from the package. Keep the packaging until the shade operates to your satisfaction.
- Check the diagram to make sure you have the necessary parts.

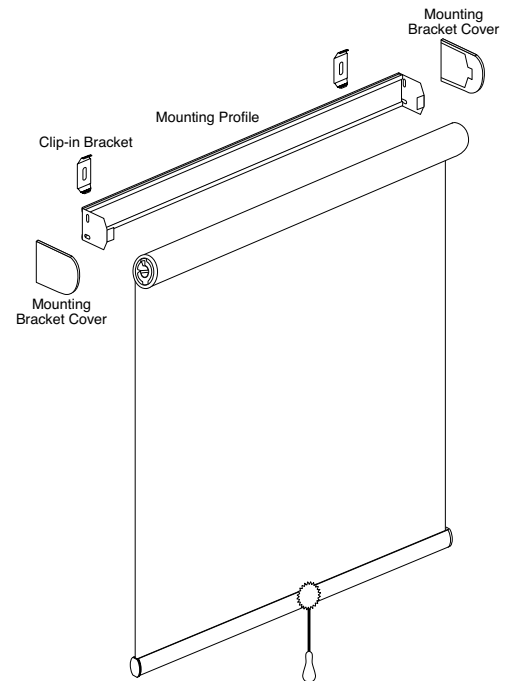

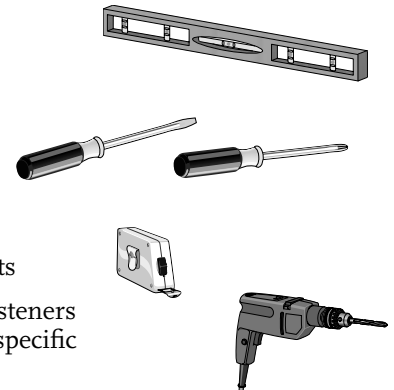

Tools needed for installing your shade:

- Carpenter's Level
- Flat Blade Screwdriver
- Phillips Screwdriver
- Measuring Tape
- Power Drill and Drill Bits



In addition, you will need fasteners designed to work with your specific mounting surfaces:

Mounting Surface	Fastener
Wood	No. 6 Hex Head Screws (Provided) 
Drywall, Plaster	Wall Anchors, Expansion Bolts (Not Provided) 
Metal	Sheet Metal Screws (Not Provided) 

Contents of your hardware package may vary depending upon how the shade was ordered and whether the shade will be mounted inside or outside the window opening.

For assistance, call the Hunter Douglas Customer Information Center at
 1-888-501-8364
 7:00 AM to 4:30 PM MST, Mon.-Fri.
 Visit our Web site at hunterdouglas.com

SoftRise™ Shade Installation

The SoftRise™ shade arrives ready to install as a complete unit, using the small clip-in brackets provided. Refer to the chart below for the necessary number of clip-in brackets. The shade may be mounted as a wall mount or an inside/ceiling mount shade.

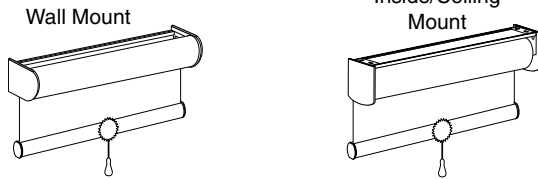

CLIP-IN BRACKET CHART	
Up to 36" shade	2 brackets
36-1/8" to 60"	3 brackets
60-1/8" to 72"	4 brackets

DO NOT REMOVE THE SHADE FROM THE MOUNTING PROFILE BRACKETS!

When installing the shade, grip the shade from the bottom portion as shown.

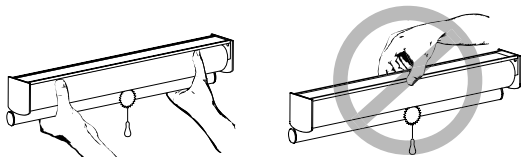

Do not hold from profile!

- Mark 1" to 2" from the left and right edge of the window and mark.
- Center a clip-in bracket over each mark on the mounting surface.

For Wall Mount Shades, the tab of the clip-in bracket should be facing down. (See diagram)

For Inside/Ceiling Mount Shades, the tab of the clip-in bracket should face towards the window.

- Use a carpenter's level to check that the brackets are level and aligned.
- Attach the clip-in bracket with the necessary screws.
- If additional clip-in brackets are required, space brackets evenly between the end brackets, adjusting for obstructions.
- For wall mount shade: With the clip-in brackets mounted, take the SoftRise™ shade, place the top groove of the profile into the lip of the clip-in bracket. Check to make sure that all clip-in brackets are aligned correctly with the profile.
- For an inside/ceiling mount shade: With the clip-in brackets mounted, take the SoftRise™ shade, place the front groove of the profile into the lip of the clip-in bracket. Check to make sure that all clip-in brackets are aligned correctly with the profile.

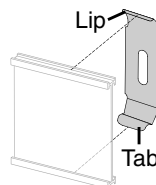
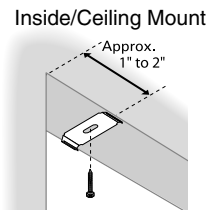
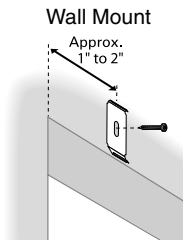
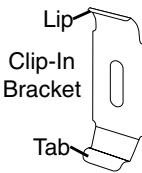

- Press the shade firmly against the tab of the clip-in bracket until it snaps into place, again making sure that all clip-in brackets are aligned correctly.

- Test your shade for level. If the shade is not level, remove the profile from the brackets by pressing on the bracket tab. Place a shim under one or more of the brackets and remount the shade.
- Remove the paper band from the shade.

SoftRise™ Spring Rewinding

The SoftRise™ spring may deactivate during shipping or in the course of use and may not operate properly.

To reset the SoftRise™ spring:

- Lower the shade completely and lock the shade.
- Remove the shade from the brackets by rotating the release tab on the AutoStop clockwise and gently pulling the AutoStop side of the shade upwards. Then pull the opposite side from the bracket.
- Once shade is removed, manually roll the fabric back up completely.
- Turn the AutoStop **clockwise** until it comes to a stop. (This may require many rotations.)
- Reinstall the shade into the brackets.
- The shade should stop approximately 1" to 2" from the roll. The distance may vary depending on shade width and fabric type.

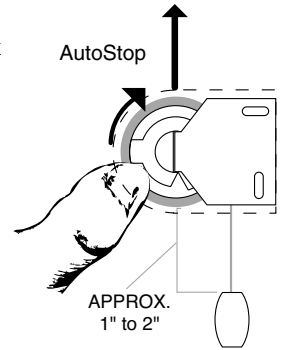

Should the shade raise very slowly:

- Lower the shade approximately 25% and lock into place.
- Remove the shade from the brackets.
- Manually roll the fabric on the roller completely.
- Turn the AutoStop clockwise until it comes to a stop.
- Reinstall the shade.

Care and Cleaning

Normal cleaning of all Remembrance® window shades requires only light dusting with a feather duster, soft cloth, or low suction vacuum attachment. Do not clean with harsh detergents.



HunterDouglas
window fashions

hunterdouglas.com

Where Great Rooms Begin.

© 2003 Hunter Douglas Inc. ® Registered trademark of Hunter Douglas Inc.
™ Trademark of Hunter Douglas Inc. Patented in the U.S. and foreign countries.
U.S. and foreign patents pending.