

Installation and Care Instructions

CADENCE™
THE NEW dimension in verticals

Soft Vertical Blind Collection



Paramount® Headrail System

HunterDouglas
window fashions

THANK YOU for purchasing a Hunter Douglas product. Your new blind has been custom built for you from the highest quality materials. Once in your window, it will provide you with a lifetime of beauty and trouble-free use.

Getting Started

- Remove headrail*, louvers and valance from the package. Be careful not to bend the louvers when you are removing them. Do not discard any of the packaging material until the blind operates to your satisfaction.
- Check the diagram below to make sure you have the necessary parts.
- Contents of your hardware package may vary depending upon whether the headrail is mounted inside or outside the window.

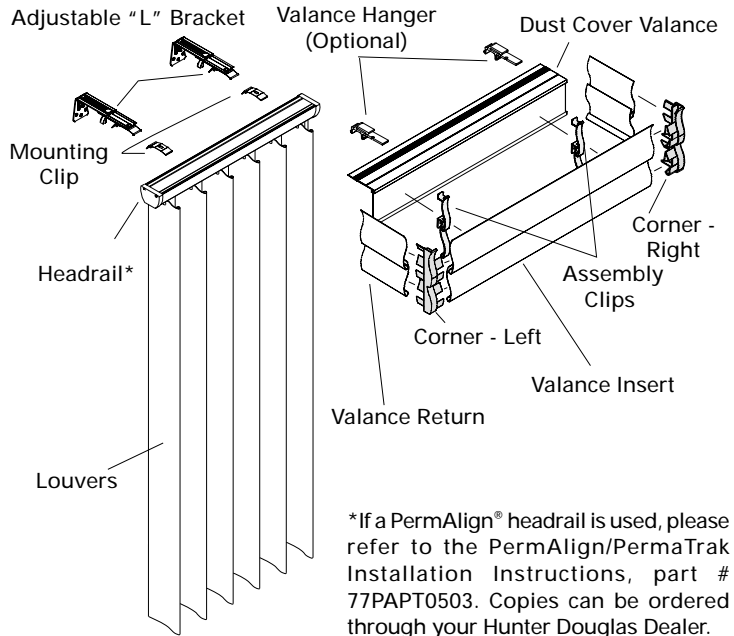

**For assistance, call the Hunter Douglas Customer Information Center at
1-888-501-8364
7:00 AM to 4:30 PM MST, Mon. – Fri.
Visit our Web site at hunterdouglas.com**

Tools needed for installing your blind:

- Drill
- Flat Blade Screwdriver
- Measuring Tape
- Pencil
- Phillips Screwdriver

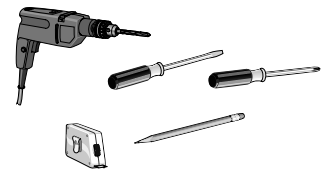

In addition, you will need fasteners designed to work with your specific mounting surfaces:

Mounting Surface	Fastener
Drywall, Plaster	Wall Anchors, Expansion Bolts (Not Provided)
Metal	Sheet Metal Screws (Not Provided)
Wood	No. 6 Hex Head Screws (Not Provided)

1 Dualfold™ Valance Assembly - Double Tiered

- It is necessary to pre-assemble the Dualfold Valance prior to headrail installation. You will need the following components for assembly: (see Illustration A)

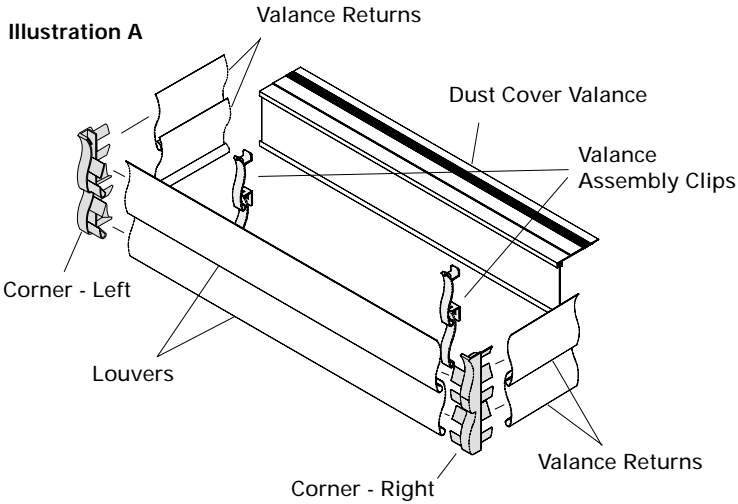

- Slip curved edge of top valance louver over round end of assembly clip (see Illustrations B & C).

NOTE: The Dualfold Valance should be assembled upside down.

Illustration B

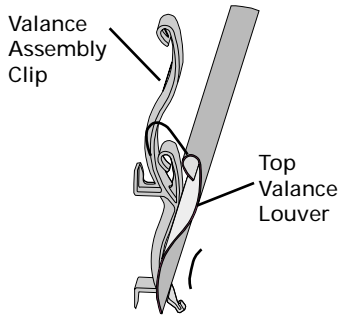
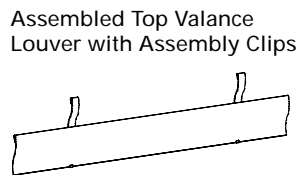

Illustration C



- Slide curved edge of bottom valance louver over round edge of assembly clip.

NOTE: Lower edge of bottom valance louver should be between top louver and assembly clip (see Illustration D).

Illustration D

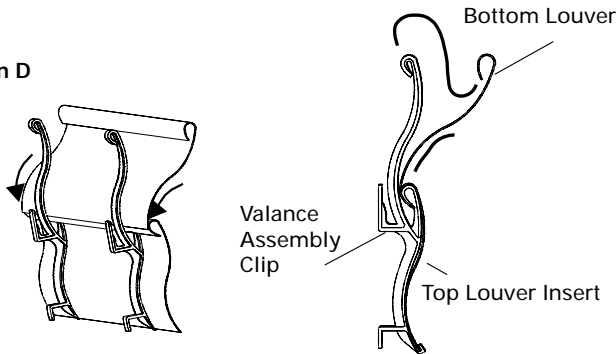

- Insert and slide brackets on back of assembly clip into clear grooves on front of dust cover (see Illustrations E & F).

Illustration E

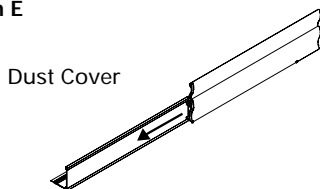
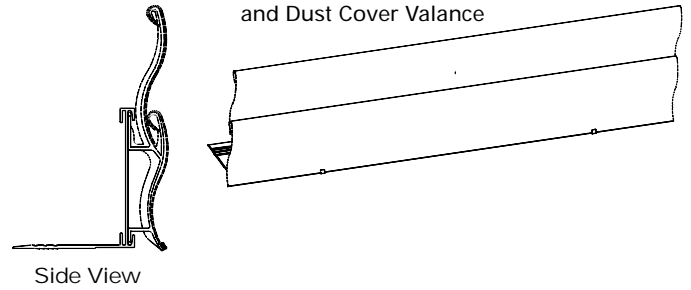

Illustration F



- Install valance corners (see Illustrations G & H).

NOTE: Angle corner as it is inserted into louvers.

Illustration G

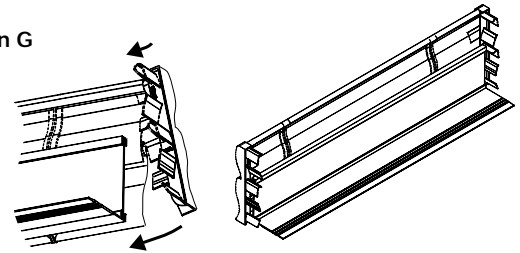
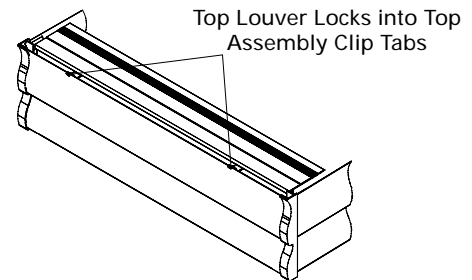

Illustration H



- The valance assembly is complete. Position valance upright (see Illustration I).

Illustration I



2 Inside Mount Installation

Locate the mounting clip between 2" and 4" from each end of the headrail. Evenly space intermediate clips between end clips at 30" intervals. If available, use mounting template to determine consistent mounting depth (see Illustration J).

NOTE: If you do not have a mounting template, measure depth to allow a 1/4" clearance between louver and window (i.e. 2-1/2" for 3-5/8" louvers).

Illustration J

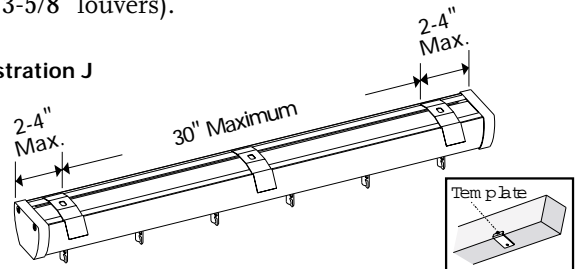

- Mark drill holes 3" from each end of valance and evenly space intermediate drill holes between the end holes at 30" intervals.
- Inside surface of the valance has three parallel lines. Align drill holes with center line (see Illustration K).

Illustration K

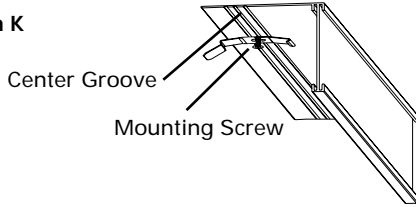

- Turn the Dualfold Valance upright. Insert valance into window opening with returns flush to the wall.

NOTE: Returns may need to be trimmed to desired length.

- Hold valance in position and drill through into ceiling.
- Insert screw through the mounting clip and tighten the valance against ceiling into finished mounting position (see illustrations L & M).

Illustration L

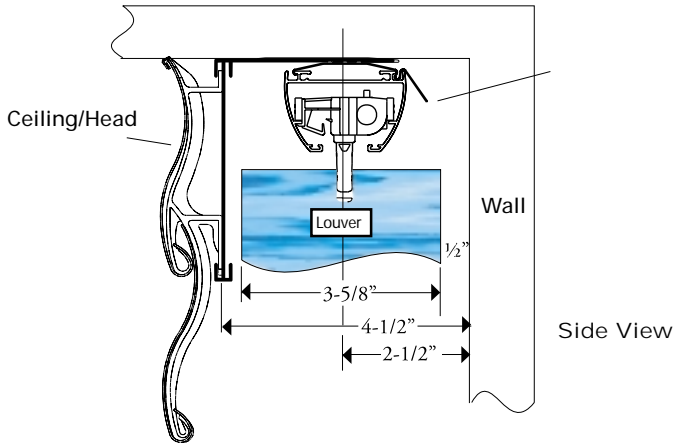

- Center headrail underneath the mounting clips.
- Tilt headrail and insert it into the front ledge of the mounting clips. Pull forward and roll headrail toward rear of blind and snap into place (see Illustration M).

Illustration M

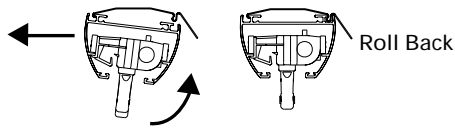

- To remove headrail, locate the rear tab on mounting clip. Push up on the rear tab of mounting clip to release the track.

3 Outside Mount Installation

- Mount "L" brackets 2" to 4" from each end of the headrail. Evenly space intermediate brackets between end brackets at 30" intervals (see Illustration N).

Illustration N

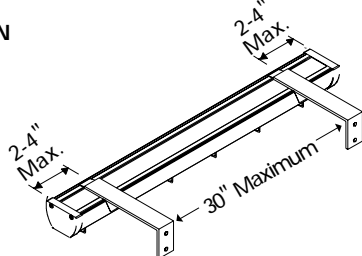

- Adjust mounting clips to provide 1/2" clearance between vane and the wall (i.e. 2-1/2" for 3-5/8" louvers).
- Center headrail underneath mounting clips.
- Tilt headrail and insert into the front ledge of mounting brackets. Pull and roll headrail toward rear of blind and snap into place (see Illustration M).
- "Snap" on a valance hanger next to each "L" bracket (see Illustration O).
- Center valance in relation to the headrail and slide into valance hanger.

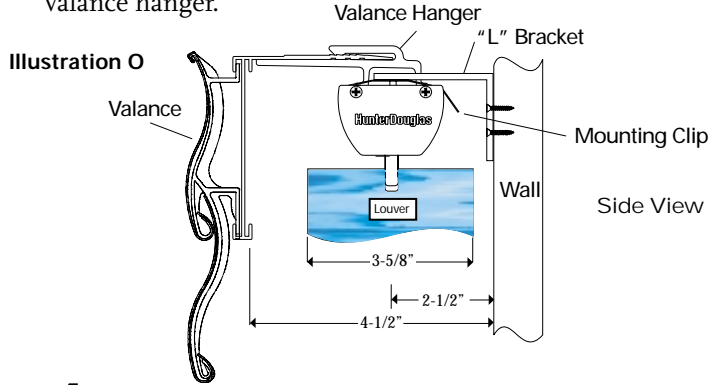

4 Attach Louvers

- Depending on your selection, you will have either Right Facing Louvers or Left Facing Louvers (see Illustration P).
- Rotate the louver hooks so the slot between the long and short prong is facing you.
- Push louver into hook until it "snaps" into place.

Illustration P

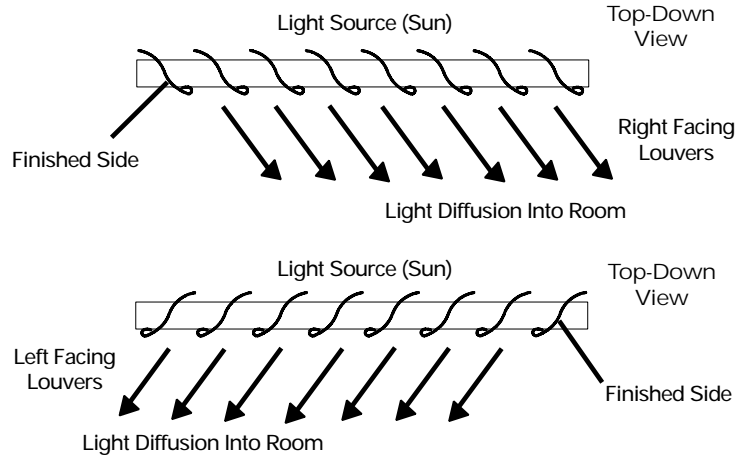

5 Remove Louvers

Gently open louver hook by inserting a credit card-size piece of rigid plastic between the louver and the long prong of the louver hook (see Illustration Q). Gently remove louver.

Illustration Q

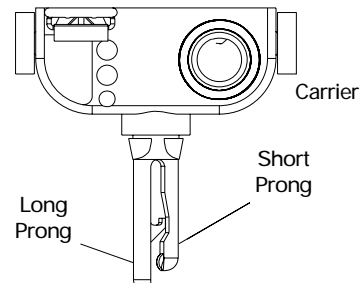

6 Cord Tensioner and Cord Length

Version One: Sill Mount

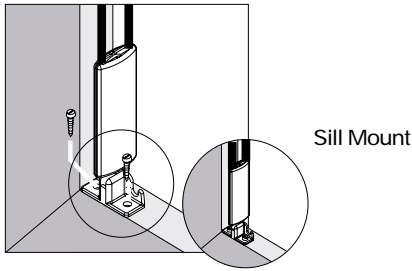

Version Two: Jamb Mount

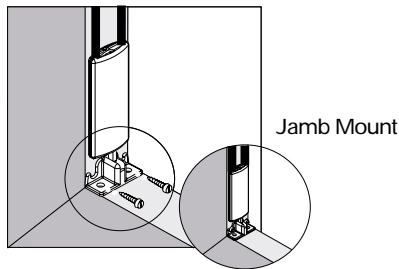

Version Three: Wall Mount

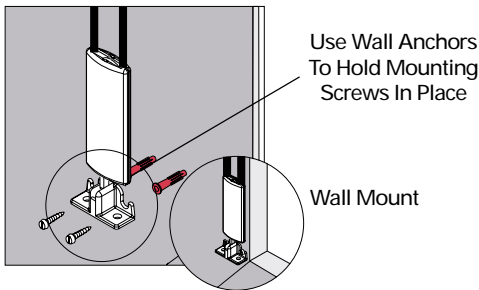

7 Cord Tensioning

- Establish preferred mounting location. If cord adjustment is required, see instructions below.
- Fully extend the tensioning device, rotate past 45 degrees, and lock in the extended position.
- Locate the mounting position.
- Hold the cord taut with the cord tensioning device in extended position and insert screws.

NOTE: Cord tensioning applies only if blind is ordered with chain and cord control system. The PermaTilt® Wand Control System comes standard on all Cadence Soft Vertical Blinds.

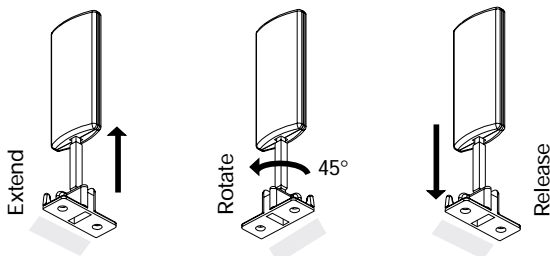

8 Cord Adjustment

To reduce the cord length on a Side Draw:

- Release tension on cord.
- Place blind in an open position.
- Locate cord knot in front of lead carrier.
- Loosen adjusting screw.
- Pull the cord to desired length.
- Tie knot and then cut any excess cord.
- Tighten adjusting screw.

Side Draw
Carriers In
The Open
Position

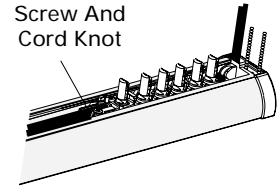

To reduce the cord length on a Center Draw:

- Release tension on cord.
- Place blind in the closed position.
- Locate cord ends in front of lead carrier.
- Loosen adjusting screw.
- Select cord knot that adjusts cord length only; if carrier movement is observed, select the other cord.

Center
Draw
Carriers In
The Closed
Position

CAUTION: Cutting the wrong cord will cause irreparable damage.

- Pull cord to the desired length.
- Tie a knot and then cut excess cord.
- Tighten adjusting screw.

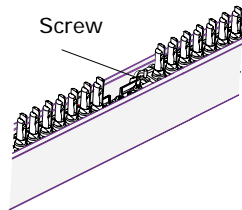

9 Care and Cleaning

Dusting

Regular light dusting with a feather duster is all the cleaning that is needed in most circumstances.

Vacuuming

Use a hand-held vacuum with low suction for more thorough dust removal.

Spot Cleaning

Prepare a solution of warm water and mild dishwashing detergent. Dampen a clean cloth in the solution and wring it out. Dab the spot with the dampened cloth until it is gone.

Compressed Air

You can use compressed air or a hair dryer (non-heat setting) to blow the dust off your valance.



HunterDouglas
window fashions

hunterdouglas.com

Where Great Rooms Begin.

© 2003 Hunter Douglas Inc. ® Registered trademark of Hunter Douglas Inc.
™ Trademark of Hunter Douglas Inc.
Patented in the U.S. and foreign countries. U.S. and foreign patents pending.